

## Particular Specification

Item No:	BMS-306BB
Weight:	6.6 grams / 0.23oz.
Size:	22 x 10 x 23 mm / 0.86 x 0.4 x 0.9 inch
Torque At 4.8V:	1.1kg/cm , 15 oz/in
Torque At 6.0V:	
Speed At 4.8V:	0.10 sec / 60 deg at no load
Speed At 6.0V:	
Ball Bearing:	Yes, Top of Single Ball Bearing
Metal Gears:	None, All of nylon gears
Motor Type:	3 pole magnetic motor
Operating Voltage Range	3.6V ~ 4.8V
Operating Temperature Range	-20°C to +60°C
Idle Current	5mA at Stopped
Running Current	190mA
Stall Current	470mA
Dead Bend Width	6 usec
Direction	Re-clock wise / pulse traveling 1200 to 1600 usec
Horn Gear Spline	20 Segments (External diameter: 3.6mm)
Connector Wire Length	160mm (6.29in)
Connector Horsing	Universal connector
Wire Info	Brown Wire = Battery Negative Red Wire = Battery Positive Orange Wire = Signal

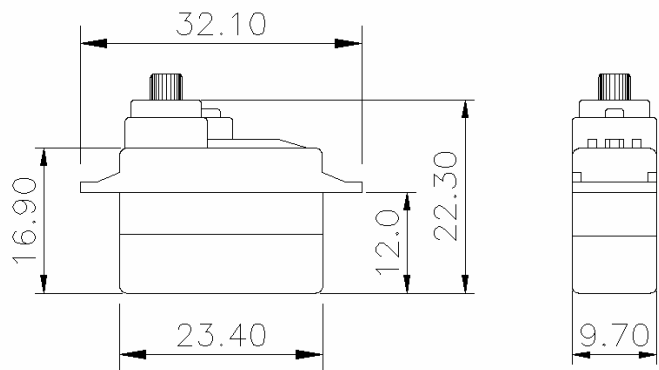
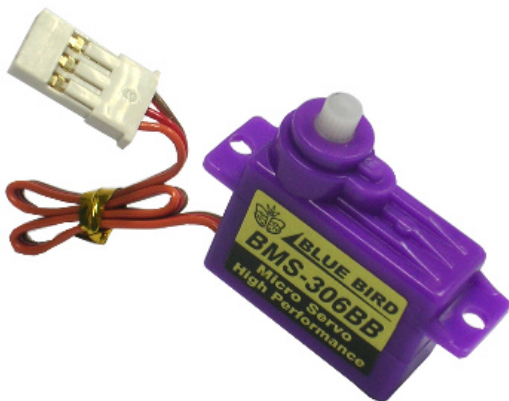

**Unit: mm**